

LISTA RICAMBI / ERSATZTEILLISTE / LIST OF SPARES

Numero Number	Descrizione Bezeichnung Description		N° di ricambi Ersatzteil-Nr. Spare part ref.
1	Luci Scheinwerfer Headlamps	HR2946	HR2409/01
		HR2947	HR2409/01
		HR2948	HR2948/01
		HR2949	HR2949/01
3	Corrimano Handläufe Handrails		HR2409/03
4	Camino Schornstein Chimney	HR2946	HR2880/04
		HR2947	HR2947/04
		HR2948	HR2947/04
		HR2949	HR2880/04
8	Motore Motor Motor		HR2409/08
9	Supporto Träger Support		HR2409/09
10	Scheda Principale a circuiti Stampati Hauptleiterplatte Main PCB		HR2409/10
11	Confezione Attacco Kupplungsatz Coupling Pack		HR2409/11
12	Carrozzeria con gruppo cilindri Rahmen mit Zylinder Frame with valve gear	HR2946	HR2883/12
		HR2947	HR2947/12
		HR2948	HR2947/12
		HR2949	HR2949/12
13	Albero cardanico Kardanwellen Cardan shafts		HR2409/13
14	Carrello folle completo Drehgestell, komplett Driven bogie, complete	HR2946/47/48	HR2409/14
		HR2949	HR2882/14
15	Set ruote folli Radsätze Wheel set		HR2409/15
16	Set bielle Kuppelstangen Connection rods		HR2409/16
17	Set aggiuntivi Zurüstbeutel komplett Accessories bag	HR2946/47/48	HR2409/17
		HR2949	HR2882/17

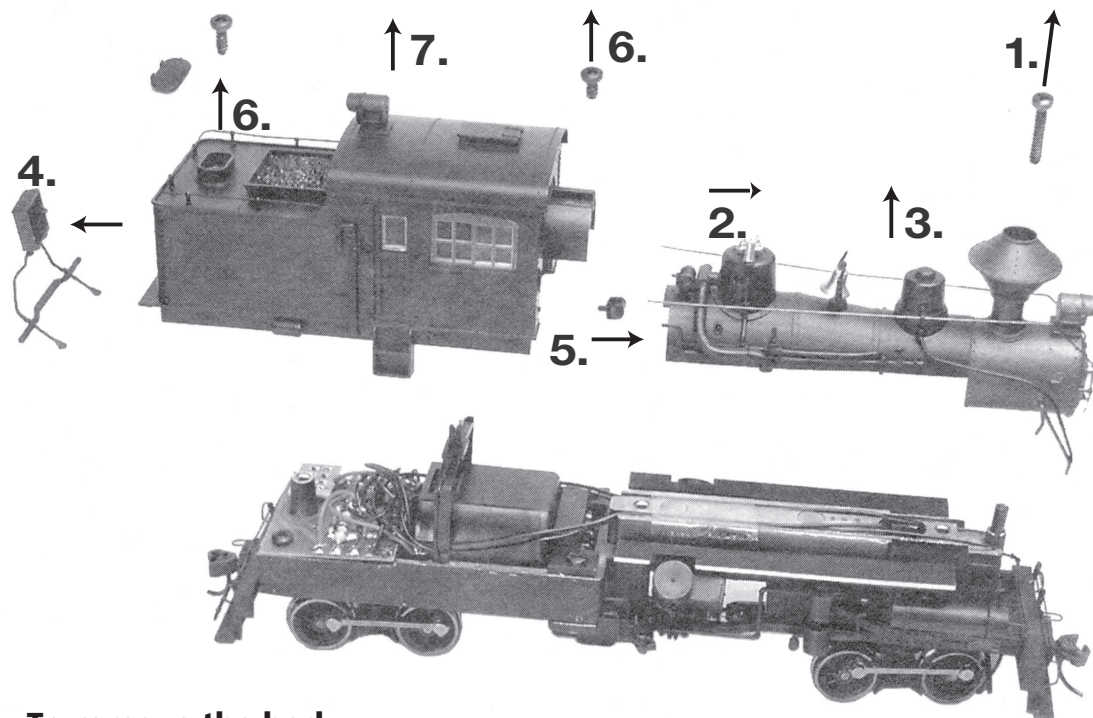

To remove the body:

- ① Remove the screw from the chimney.
- ② Carefully move the boiler towards the front.
- ③ Lift the boiler from the chassis.
- ④ Remove the box located at the rear of the tender.
- ⑤ Remove the part from the right front side of the cabin.
- ⑥ Remove the cover of the water tank and the screws.
- ⑦ Lift the body shell from the chassis.

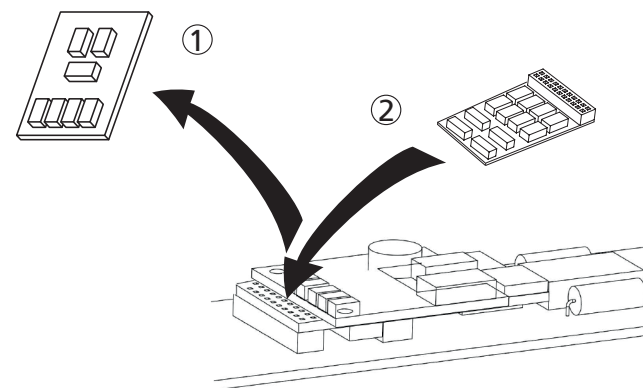

To install a digital decoder:

- ① Remove the analog decoder.
 - ② Insert the digital decoder.
- Please, note its correct position (index pin).

